

Resistors in Microwave Applications

Due to the rapidly increasing number of high frequency applications, the resources below 1 GHz are becoming scarce. For this reason the frequency range up to and above 40 GHz is becoming more and more important, and thus also the need to understand the frequency characteristics of passive components in microwave field.

In this paper, the high frequency behavior of chip resistors sizes 0805 and 0603 will be shown from 0,1 to 20 GHz. A comparison with special trimmed cylindrical resistors sizes 0204 and 0102 will be taken. First the conditions for a good high frequency performance will be demonstrated. The paper continues with an analysis of the influence of the calculated parasitics in the substitution circuit. Plots of the test data of the high frequency characteristics complete the representation.

Special HF-Resistors Needed

The number of high frequency applications is rapidly increasing today. Consequently the need for resistors with good high frequency performance is growing.

Some years ago 500 MHz was an "ultra" high frequency. Nowadays frequencies up to 2 GHz are nothing special. Mobile phones operate in the 900 MHz frequency range (GSM) and 1,8 GHz (DCS) respectively. The DECT-standard will become more and more important, it is based upon 1,8 GHz too. By using this standard the telecom providers do not need to install an expensive telephone line to each telecom customer. For mass applications there are satellite TV-receivers working at frequencies between 10 and 12 GHz and an intermediate frequency up to 2 GHz. Last but not least ISM applications, for example wireless LANs, become more and more important. Most popular bands are 430 MHz and 2 GHz today, but also the 5 GHz band is increasingly used.

Former measurements [1] confirm the expectation that the usual helical trimming of a cylindrical resistor causes increased influence of reactances at high frequencies. This effect can be reduced by means of a special pulsed trim. The following illustration (Figure 1) shows the comparison between a helical trimmed MINI-MELF resistor (size 0204) and the pulsed trimmed version. The difference is significant.

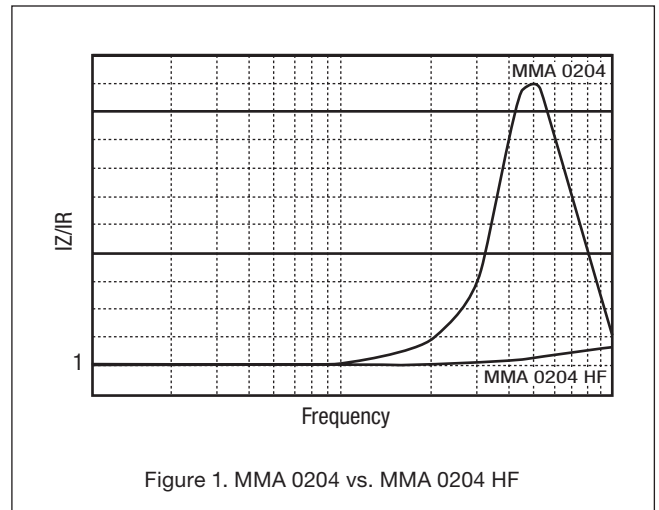

Figure 1. MMA 0204 vs. MMA 0204 HF

Theoretically a resistor is frequency-independent. Actually there is an additional contribution to the impedance by an inductance L and a capacitance C to the actual resistance value R . The inductance results from the trim cutting, the capacitance is formed by the ceramic dielectric of the resistor body and the metallic contacts.

The following substitution circuit is used to describe the resistance behavior (Figure 2). The capacitors C_i are formed by integrating the resistor into the circuit.

Figure 3 presents the trim cuttings of different resistors. On the top there is the well known helical trim cutting with its comparatively high inductance of up to 22 nH [1]. At

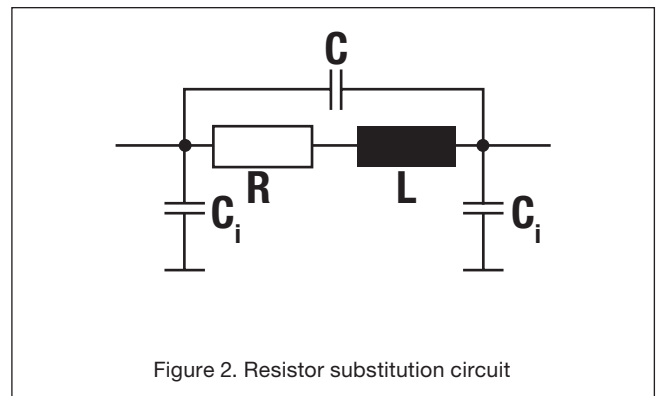

Figure 2. Resistor substitution circuit

Resistors in Microwave Applications

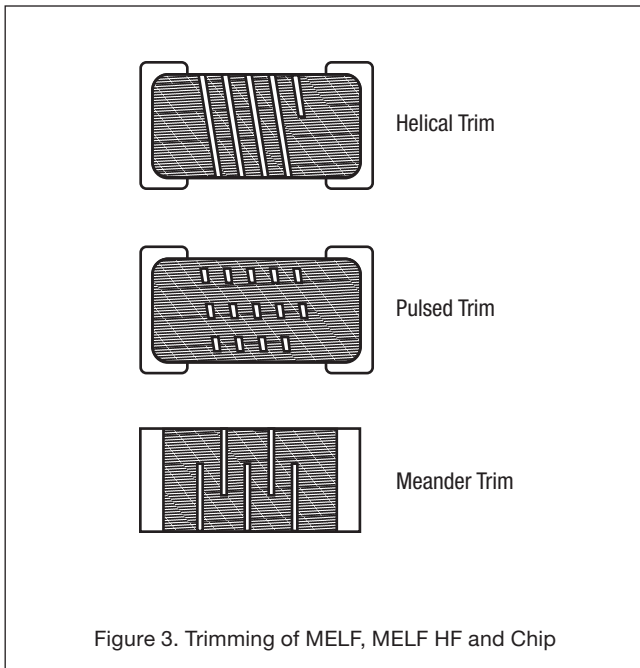

Figure 3. Trimming of MELF, MELF HF and Chip

the centered picture there is the special HF trim cutting as further trim for cylindrical resistors. The typical meander trim cutting of flat chip resistors is shown on the lower drawing.

Requests for High Frequency Performance

For high frequency applications, there are other demands more important than tolerance and temperature coefficient.

1. For most of the practical applications, the resulting deviation of the impedance Z up to $|Z| / R = 1,2$ may be disregarded. For higher deviations, the resistor is not acceptable or the occurring reactances have to be regarded into the circuit.
2. The working frequency has to be far below the resonance frequency. Near the resonance minor changes in working frequency cause major changes in impedance – the circuit is likely becoming instable.
3. Computer simulation is an easier way to design microwave circuits. Therefore, the resistor must be able to be modeled by a simple model.
4. High frequency characteristics must be reproducible in series production in order to avoid individual trimming of print boards by the manufacturer.

Measuring High Frequency Performance

How to measure inductance and capacitance at microwave range? The only way to get the required data is to measure

scattering parameters by a vector network analyzer. This measuring device determines ratios of incident, transmitted and reflected waves.

In our case there are two important scattering parameters: the input reflection coefficient S_{11} and the transmission coefficient S_{21} .

S_{11} is the ratio of the reflected to the incident wave, and S_{21} the ratio of the transmitted to the incident wave respectively.

Results

Resulting data determined by a vector network analyzer are real and imaginary part of S_{11} and S_{21} . There are two possible calculating methods for the impedance:

1. The magnitude of the reflection coefficient is calculated to

$$|S_{11}| = \sqrt{\text{Re}\{S_{11}\}^2 + \text{Im}\{S_{11}\}^2} \quad (1)$$

According to [2] the complex input reflection coefficient of a series resistor is

$$S_{11} = \frac{Z}{Z + 2 \cdot Z_0} \quad (2)$$

where $Z_0 = 50\Omega$

Result of combining these two equations is:

$$|Z| = \frac{2 \cdot Z_0 \cdot |S_{11}|}{1 - |S_{11}|} \quad (3)$$

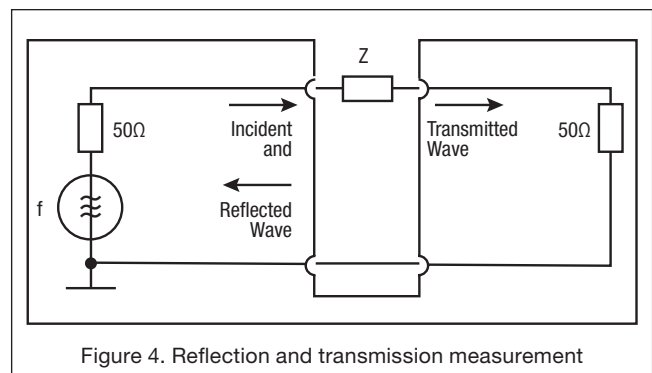

Figure 4. Reflection and transmission measurement

Resistors in Microwave Applications

To compare different resistance values it is necessary to standardize $|Z|$ by referring it to the actual resistance R .

The other way to calculate $|Z|$ by using S_{21} is:

- The magnitude of the transmission coefficient is calculated to

$$|S_{21}| = \sqrt{\text{Re}\{S_{21}\}^2 + \text{Im}\{S_{21}\}^2} \quad (4)$$

According to [2], the complex forward transmission coefficient of a series resistor is:

$$S_{21} = \frac{Z_0}{Z_0 + \frac{1}{2}Z} \quad (5)$$

Result of combining equations (4) and (5) is:

$$|Z| = 2 \cdot Z_0 \cdot \frac{1 - |S_{21}|}{|S_{21}|} \quad (6)$$

The measurement and calculation results are shown at figures 6 to 9 at the last two pages.

The considered resistance range is 6,8 Ω up to 470 Ω . These are the most important resistance values for today's microwave engineering.

In principle there is the same qualitative behavior valid for all styles and sizes.

- The inductance predominates for resistance values up to approximately 75 Ω for MELF size and 120 Ω for chip size. The resonance frequency is above 20 GHz.
- The capacitance characterizes resistance values greater than the above mentioned.

There are differences between styles and sizes in detail.

- By using the same trim cutting the high frequency behavior becomes better for smaller body dimensions of the resistor.
- Comparing the trim cuttings the special pulsed trim cutting of MELF resistors is better than the standard meander trim cutting of flat chip resistors.

As an example a comparison is made for 50 Ω resistors in the diagram above. There is demonstrated that the meander trim causes a higher inductivity than the pulsed trim of cylindrical HF sizes. However, the high frequency behavior of flat chip resistors is much better than that of helical trimmed cylindrical resistors.

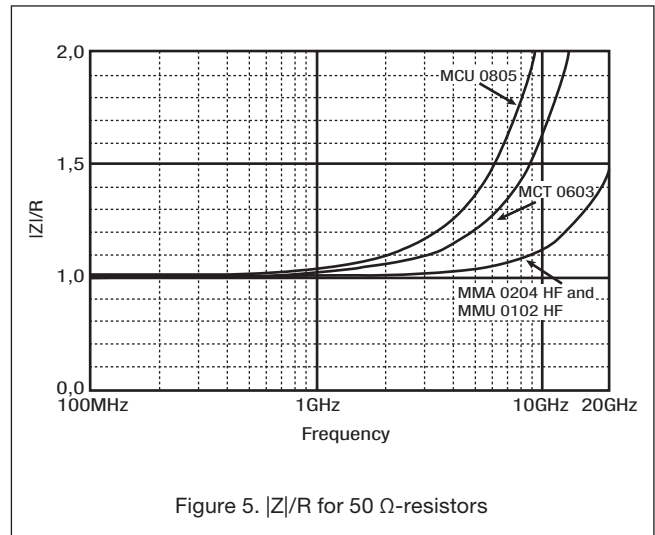

Figure 5. $|Z|/R$ for 50 Ω -resistors

Modelling and Simulation

A lot of microwave circuits are designed by using simulation programs. The simulation considers the internal inductance and capacitance. It is possible to apply the resistor at frequencies which would otherwise be not acceptable due to the variations of impedance. For the resistor model the above mentioned substitution circuit is used. Analyzing the circuit results in the following equation for the complex impedance Z :

$$Z = R \cdot \frac{1 + j\omega \frac{L}{R}}{1 - \omega^2 LC + j\omega RC} \quad (7)$$

Because $\omega^2 LC$ is a very small value it can be disregarded for most of the practical cases. Now the frequency characteristic depends only on the ratio of L/R to $R \cdot C$. In the case they are equal the impedance of the resistor is frequency independent.

In the following table some examples are pointed for the required L for a given C in dependency of R . This overview is useful to getting a feeling for the dimensions of C and L .

	R	C	$L = R^2 \cdot C$
MCT 0603	6,8 Ω	35 fF	0,0016 nH
and	50 Ω	35 fF	0,875 nH
MMU 0102 HF	470 Ω	35 fF	7,7 nH



Resistors in Microwave Applications

In order to calculate the magnitude of the impedance based on equation (7), the numerator and the denominator will be handled separately.

$$|Z|=R \cdot \sqrt{\frac{1+\left(\omega \frac{L}{R}\right)^2}{1+(\omega RC)^2}} \quad (8)$$

By using this equation, it is possible to plot the $|Z|/R$ characteristics over the considered frequency range. Comparing measured data with calculated graphs, allows to determine the reactances of the substitution circuit.

The following table contains some determined values of capacitance and impedance:

	R	C	L
MCT 0603	6,8 Ω	35 fF	0,58 nH
	50 Ω	35 fF	1,0 nH
	470 Ω	35 fF	1,53 nH
MMU 0102 HF	6,8 Ω	35 fF	0,2 nH
	50 Ω	35 fF	0,41 nH
	470 Ω	35 fF	2,37 nH

Up to now this method takes into account only the magnitude of the impedance. The necessary next step is to calculate phase angle by using equation (7).

The phase angle is defined as

$$S_{11} < = \tan \frac{\text{Im}\{S_{11}\}}{\text{Re}\{S_{11}\}} \quad (9)$$

Comparing measured with calculated data quantifies the substitution circuit completely.

Conclusions

The very good high frequency performance of special trimmed HF MELF resistors and standard meander trimmed flat chip resistors qualify these components for microwave applications for more than 5 GHz depending on actual requirements. For best microwave characteristics, MICRO-MELF MMU 0102 HF is the first choice. For mass applications up to 3 GHz flat chip resistors MCT 0603 and MCU 0805 are applicable without problems.

Nevertheless, for better HF characteristics it is possible to optimize actual flat chip resistors. Further miniaturization will also offer better HF performance.

Bibliography / References

- [1] Laurich, W.: SMD Resistors Beyond UHF, CARTS - EUROPE 1990, page 41
- [2] Meinke/Gundlach: Taschenbuch der Hochfrequenz-technik, Springer Verlag, page C11

Resistors in Microwave Applications

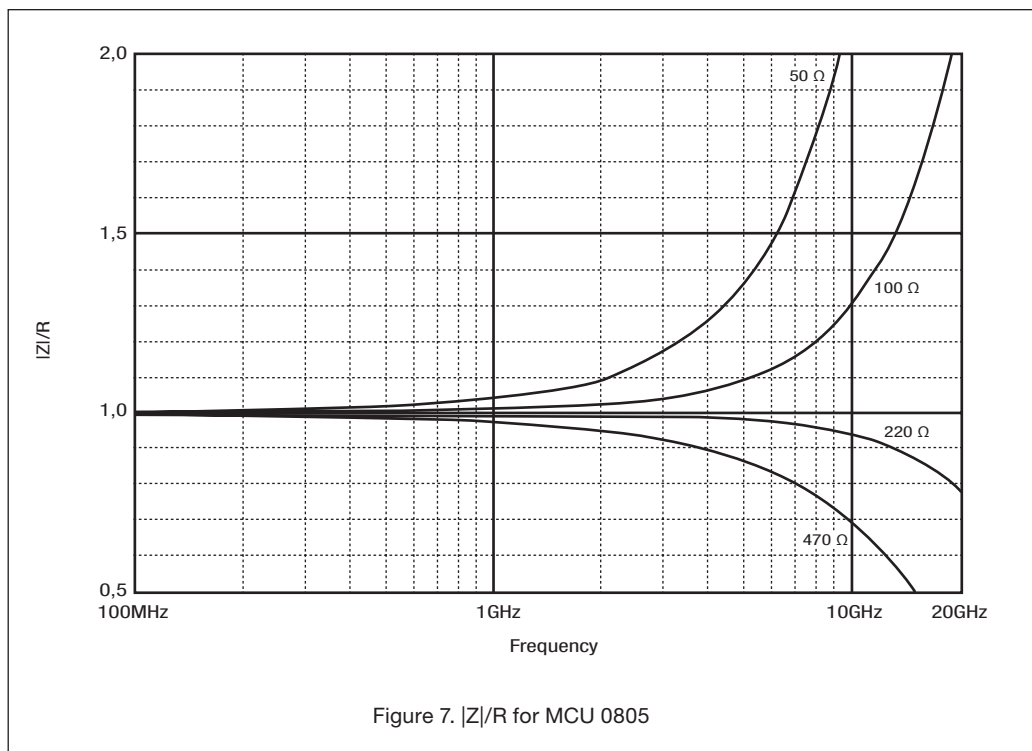
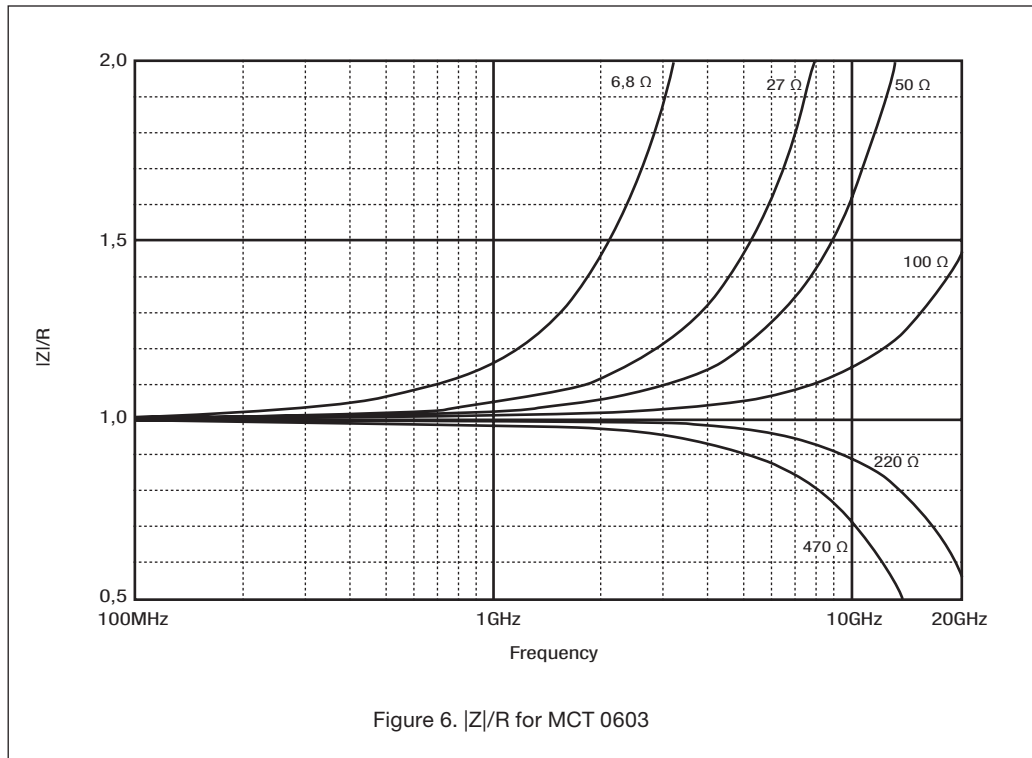



Resistors in Microwave Applications

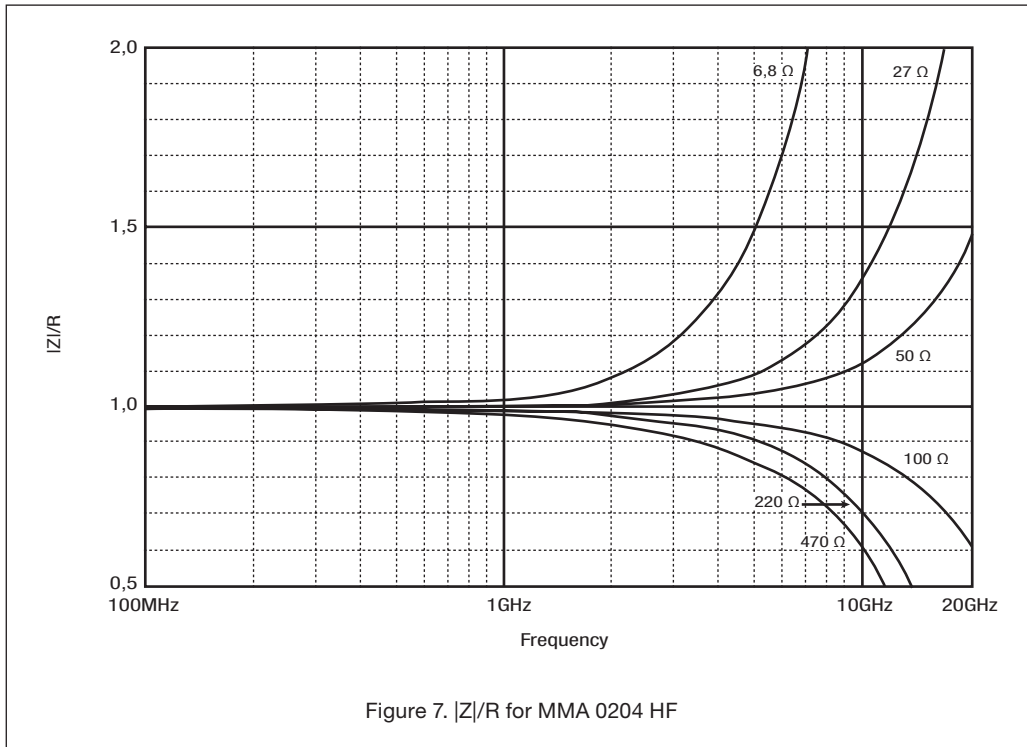
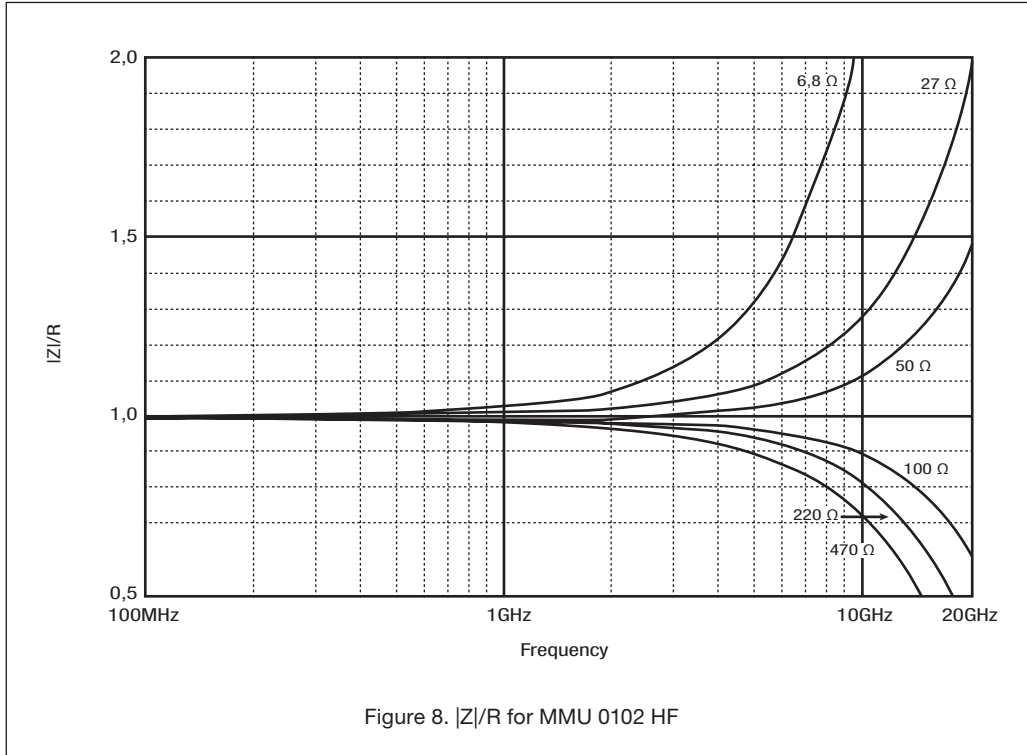



Resistors in Microwave Applications

WORLDWIDE SALES AND TECHNICAL SUPPORT

VISHAY AMERICAS

ONE GREENWICH PLACE
SHELTON, CT 06484
UNITED STATES
PH: +1-402-563-6866
FAX: +1-402-563-6296

**VISHAY INTERTECHNOLOGY
ASIA PTE LTD.**

25 TAMPINES STREET 92
KEPPEL BUILDING #02-00
SINGAPORE 528877
PH: +65-6788-6668
FAX: +65-6788-0988

VISHAY JAPAN CO., LTD.

GE EDISON BUILDING, SHIBUYA 3F
3-5-16 SHIBUYA
SHIBUYA-KU
TOKYO 150-0002
JAPAN
PH: +81-3-5464-6411
FAX: +81-3-5464-6433

VISHAY ELECTRONIC GMBH

GEHEIMRAT-ROSENTHAL-STR. 100
95100 SELB
GERMANY
PH: +49-9287-71-0
FAX: +49-9287-70435

VISHAY S.A.

4, RUE DE SALONIQUE
95101 ARGENTEUIL
FRANCE
PH: +33-1-39-98-22-00
FAX: +33-1-39-98-22-05

VISHAY LTD.

PALLION INDUSTRIAL ESTATE
SUNDERLAND, SR4 6SU
GREAT BRITAIN
PH: +44-191-514-4155
FAX: +44-191-567-8262

One of the World's Largest

Manufacturers

of Discrete Semiconductors and Passive Components